

### Easymow 260B

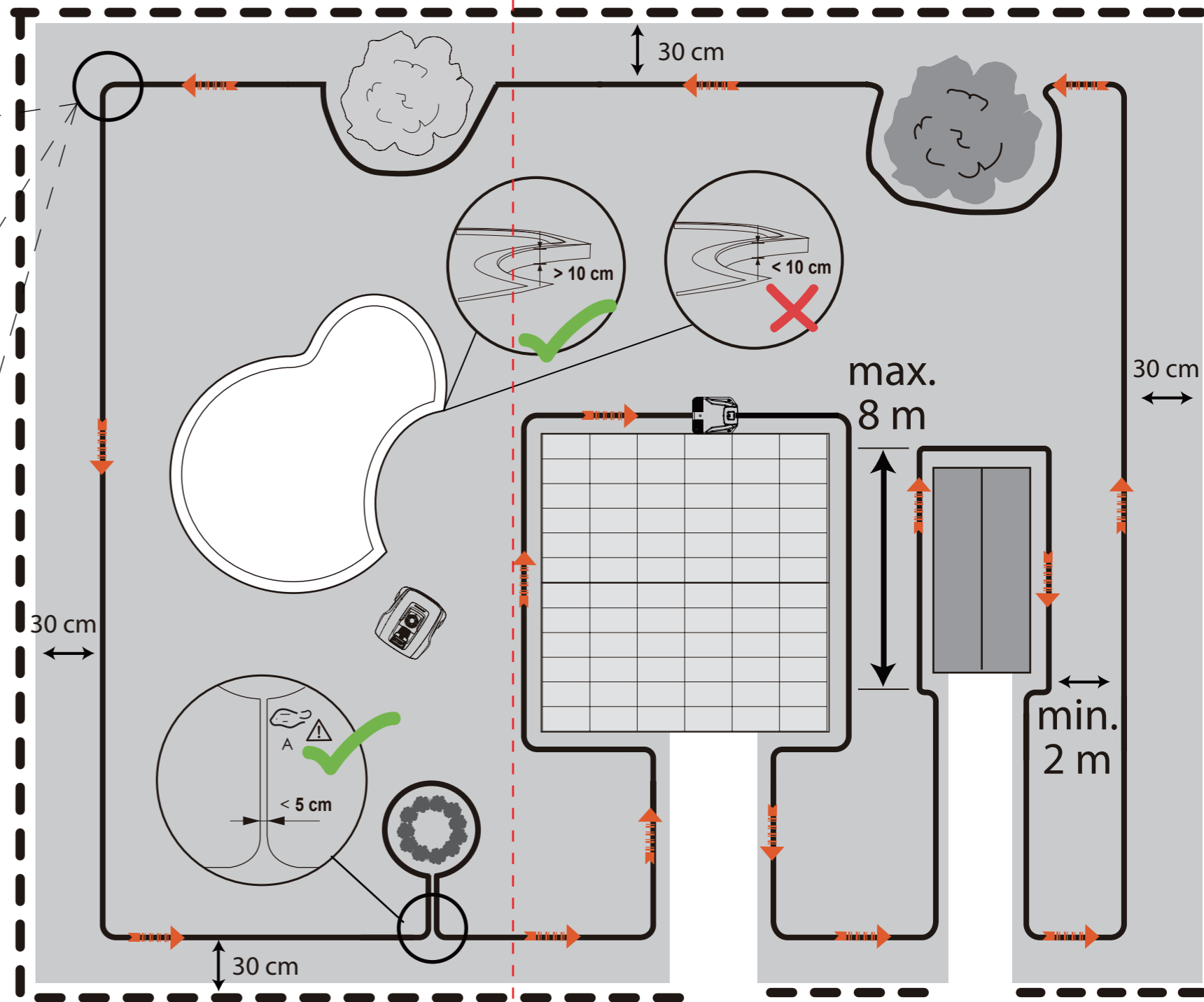

- |   |   |
|---|---|
| <b>GB</b> <b>ROBOTIC MOWER</b><br>Original Installation Guide       | <b>SK</b> <b>ROBOKOSACKA</b><br>Originálna inštalačná príručka    |
| <b>DE</b> <b>MÄHROBOTER</b><br>Original Installationsanleitung      | <b>FR</b> <b>ROBOT-TONDEUSE</b><br>Guide d'installation d'origine |
| <b>SI</b> <b>ROBOTSKA KOSILNICA</b><br>Izvorni vodnik za namestitev | <b>IT</b> <b>ROBOSEKAČKA</b><br>Guida all'installazione originale |
| <b>HU</b> <b>ROBOT FUNYÍRÓ</b><br>Eredeti telepítési útmutató       | <b>NL</b> <b>ROBOTMAAIER</b><br>Originele handleiding             |
| <b>CZ</b> <b>ROBOSEKACKA</b><br>Originální instalační průvodce      | <b>PL</b> <b>ROBOT KOSZĄCY</b><br>Oryginalna instrukcja           |

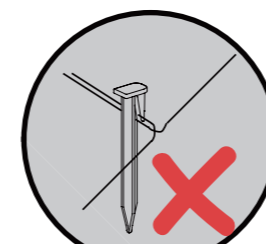
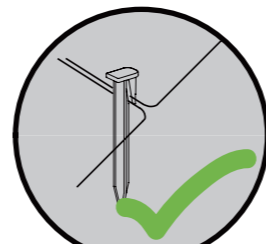
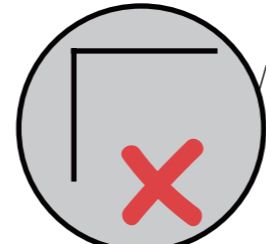

# CONTENT

- Description of the product .....1
- Installation ..... 2
- Operation .....10
- Technical data .....13
- Maintenance and storage .....14
- Troubleshooting .....16

## Description of product

1. STOP button
2. Charging port
3. Rear wheel
4. Height adjustment dial
5. Control panel
6. USB interface
7. On/Off switch
8. Front wheel
9. Cutting blade

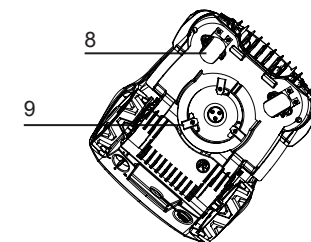
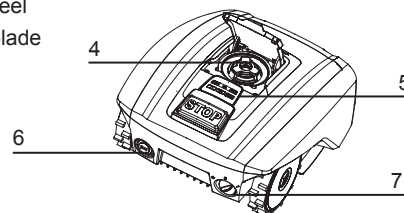
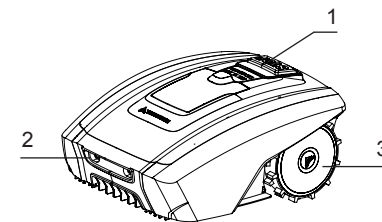

## Scope of delivery

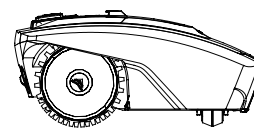

Robotic Mower

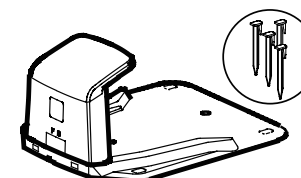

Docking station



Switching Power Supply



Extension cord

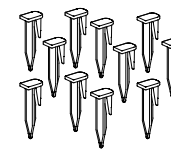

Wire pegs



Spare blades



Connectors

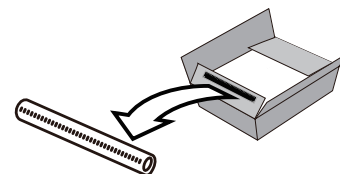

Measurement ruler

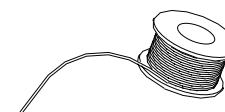

Boundary wire

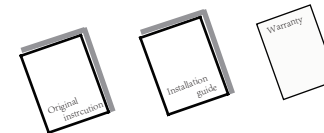

Manuals

# Installation

## Installation Guide

This chapter explains how to install the Robotic Mower. Please read this completely before you start the installation.

### Introduction

We recommend creating a drawing of your lawn, including all obstacles and how these should be protected. This makes it easier to find a good position for the docking station and how to correctly place the boundary wire around your garden perimeter protecting bushes, flower beds etc. You will also need some tools, like a hammer and wire cutters, pliers or scissors.

### Pre Cut your lawn

Your lawn needs to be prepared correctly, prior to installing the robot lawnmower. Pre cut your lawn to a height of 45 mm.

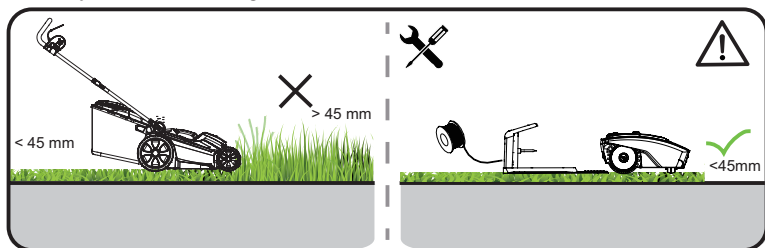

### Cutting limitations

The Robotic Mower is equipped with collision sensors. These detect all rigid and solid obstacles that are higher than 100 mm, such as walls, fences and garden furniture.

When the sensors report an obstacle, the Robotic Mower stops, backs up and then mows in a different direction. As a long-term solution, it is recommended to lay the boundary wire accordingly using the ruler to protect obstacles and the device. Lay the boundary wire so that the Robotic Mower is not more than 20 cm away from the boundary wire at any point in the mowing area.

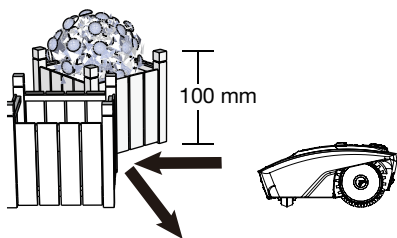

### Trees

The Robotic Mower treats trees as common obstacles, but if the roots of the tree are exposed and lower than 100mm, this area should be excluded using boundary wire in order to protect the tree root, cutting blades or rear wheels from damage.

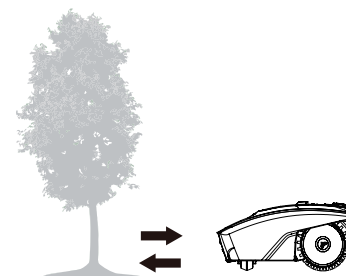

### Stones

We recommend clearing the lawn of small (less than 100 mm high) rocks and stones and any stones with a round or sloped edge. The Robotic Mower might try and climb such rocks instead of recognising them as a barrier. A Robotic Mower getting stuck on such a stone requires user intervention to restart mowing. Contact with stones can result in damage to the blades.

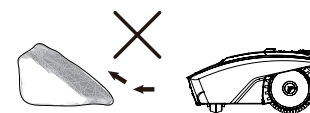

### Slopes

The Robotic Mower can navigate slopes up to a maximum of 30% incline or decline. The boundary wire should never be perpendicular to an incline of more than 10%. Also, leave strip of at least 2 m between a slope of 10% or steeper and the boundary wire. Otherwise, the higher speed going down the slope may cause the Robotic Mower to go over the boundary wire, especially on wet and slippery ground.

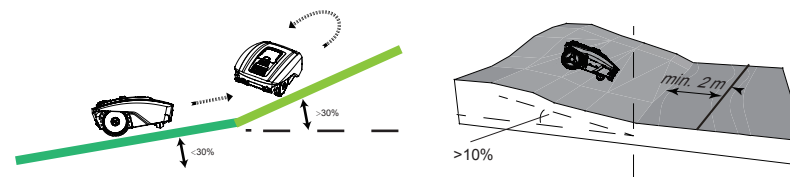

### Paths, Driveways and Roads

If an elevated driveway crosses your lawn, better keep it outside the boundary wire. Please allow a safety distance of 40 cm between driveway and boundary wire.



If the driveway and lawn are at the same level, feel free to use the boundary wire to create a corridor. This allows your Robotic Mower to cross the driveway and reach the opposite lawn.

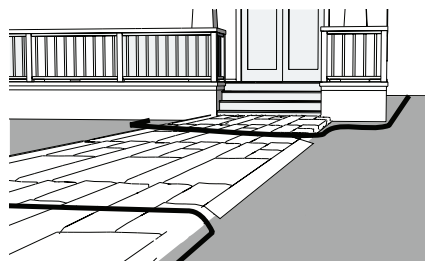

### Uneven lawn surfaces

Uneven lawn areas may cause the blades to touch the ground. We recommend leveling the lawn before using your Robotic Mower or excluding uneven areas with the boundary wire.

### Placing the docking station

Locate the best position for your docking station. Be aware that it needs a permanent connection to the mains, so take into account the location of the nearest power outlet.

To ensure the Robotic Mower can return to the docking station smoothly, leave 1.5m of straight wire to the front of the docking station and 30cm to the side facing the cutting area. Use a shaded location for the docking station, as a lower temperature while charging is beneficial to the battery. Important: Place the docking station on an even, flat surface away from ponds, pools or stairs. We recommend suitable protection from the elements, for example a robot port or garage.

Do not place the docking station too close to a slope, such as at the top of a hill or the bottom of a furrow. Avoid left and right inclination in excess of 5 degrees.

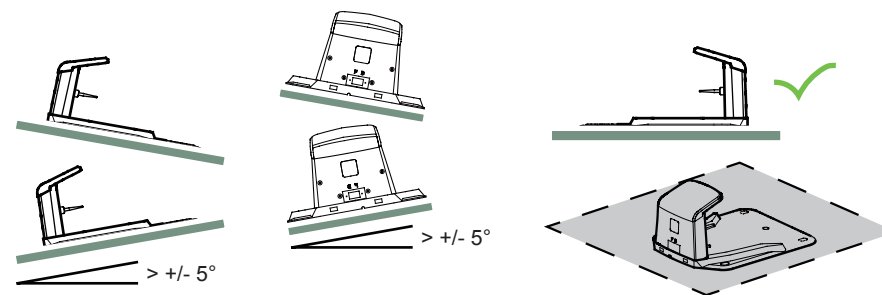
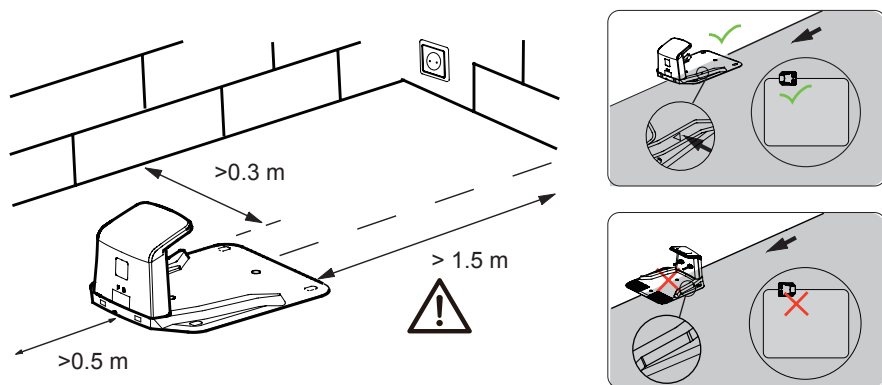

If your lawn has a soft or uneven surface, we recommend fortifying the area around the docking station with a grass protection mesh. Otherwise, the repeated stress of the rear wheels can damage the turf.

Once the position of the docking station is confirmed and mains electrical connection is laid out, please do not connect to main power yet. Finish all boundary layout work before connecting the docking station to the power supply.

### Pegging your boundary wire

We strongly recommend mowing the lawn to 45 mm or less before laying out the boundary wire. Burying the boundary wire is entirely optional. Still, the closer to the ground you lay out the boundary wire, the lower the chance of tripping over it or damaging it when mowing the lawn. Use the included ruler to ensure the required 30 cm distance between wire and obstacles.

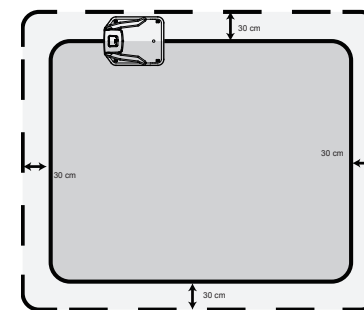

The recommended distance between two pegs is about 80 cm in straight lines, and less in tight curves. Note that the pegs' hook and wire slit always faces the outside of the boundary. Within a short time the cable will be covered with grass. Since the voltage is only 20 V, there is no risk of electric shock. Make sure that the hook of the peg and the opening for the cable always face the demarcated.

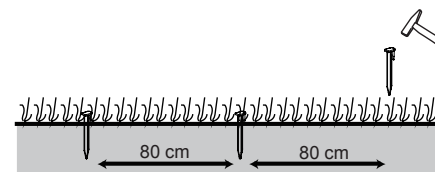

When first planting the pegs, do not drive them fully into the ground. Use a light hammer to drive them in a little bit. Also locate the fixing pegs and lay each one on the lawn at approximately the

correct distance from lawn edges (30 cm) and obstacles.

## Flowerbeds

Use the boundary wire to exclude any flowerbeds from the cutting area. There are two options for the two lengths of boundary wire running between the flowerbed and the outer boundary:

1) Keep the distance between the parallel wires above 5 cm. This way, the Robotic Mower will recognise the boundary wire as an ordinary obstacle. When cutting, it will "bounce" off it as usual. When following the boundary wire back to the docking station, it will take the detour around the flower bed.

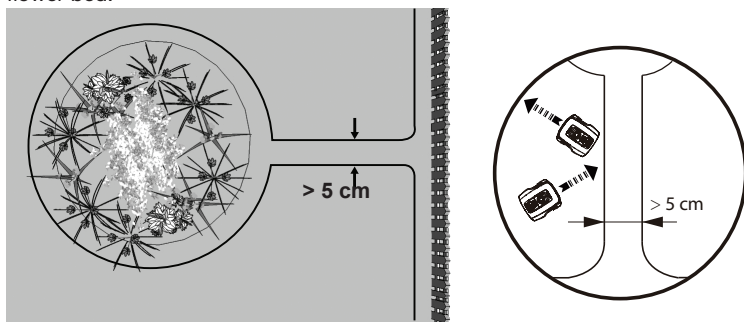

2) Alternatively, keep the distance between the two parallel wires below 5 cm. Do not cross the wires - **see below**. This way, the Robotic Mower will not recognise the wires and travel across them unhindered. This option requires placing an obstacle on the boundary wire around the flowerbed. Place the obstacle, e. g. a large rock or pole, near **position A** indicated on the below illustration. The obstacle must be surrounded by a flat area of about 1 m x 1 m, without any slopes. This obstacle will allow the machine to exit the circle.

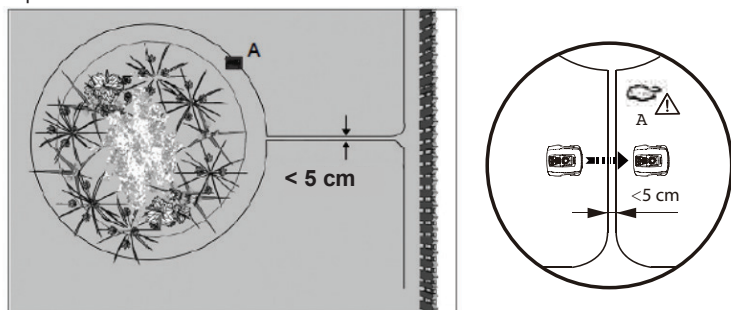

## Ponds and Pools

While the Robotic Mower is protected against rain and spray water, being submerged is likely to

cause severe damage to the electronic parts.

Therefore, it is imperative to exclude any pools from the cutting area. For added safety, we recommend placing a fence around the pool.

## Inventory and garage

If you have created a boundary corridor inside your working area, the corridor should be at least 2 m wide and a max length of 8 m.

If a corridor is too narrow or too long, the Robotic Mower might not be able to navigate it from one end to the other.

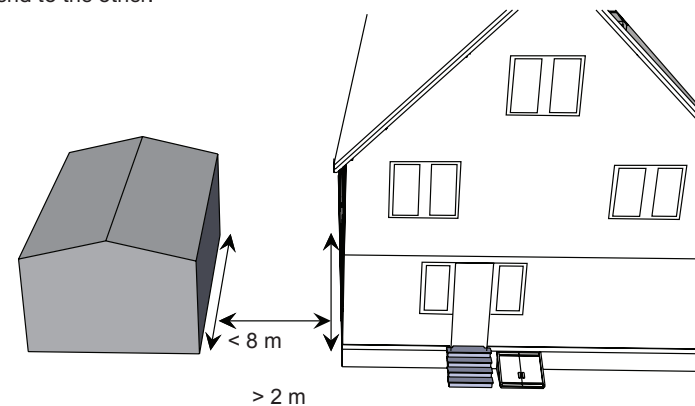

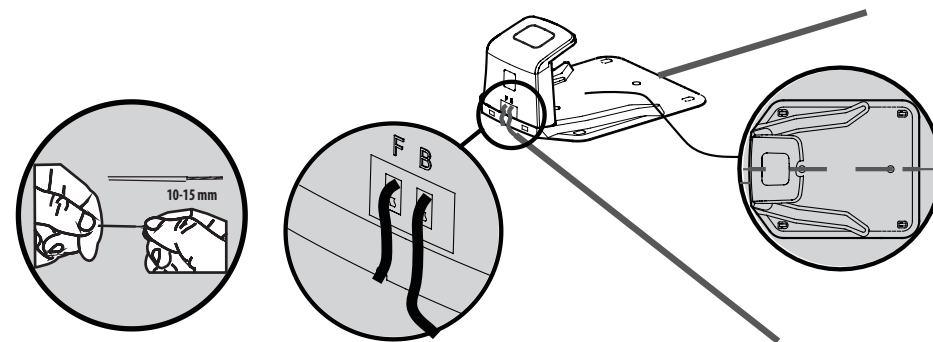

## Connect the docking station to the boundary wire

Run the boundary wire underneath the front of the docking station and connect the end of the wire to the left (black) connector marked 'F' (front). After you have placed the wire around the garden then place the other end into right (red) connector marked "B" (back).



Insert the mains plug into a properly installed socket. Once the blue LED confirms all is OK, test the Robotic Mower's function. Check the LED regularly to ensure fixing the boundary wire has not affected the connection and signal shows S1 on the charging station. Then place the Robotic Mower in the working area, a few metres beside the docking station. Set the main power switch to "ON".

Press the buttons  and , a few seconds later, the Robotic Mower should automatically return to the docking station by locating and following the boundary wire in anti-clockwise direction. If Robotic Mower fails to dock correctly, move the docking station to a more suitable position.

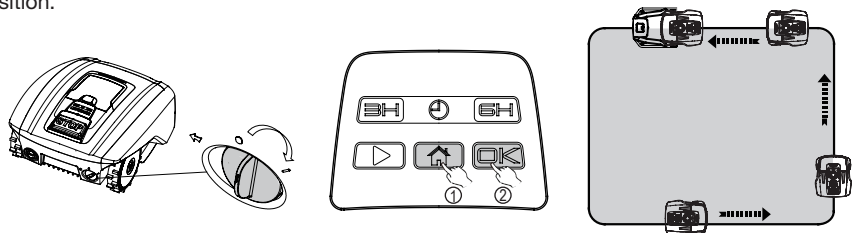

Once the device has docked, the symbol will start flashing. This indicates that the battery is charging correctly.

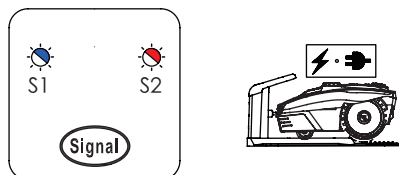

After initial installation, the Robotic Mower will remain in the docking station until the battery is fully charged.

Successful docking and charging indicates that you have found a suitable position for the docking station. You should now drive fixing pegs into ground fully.

Take care not to damage or kink the surplus wire stored under the docking station.

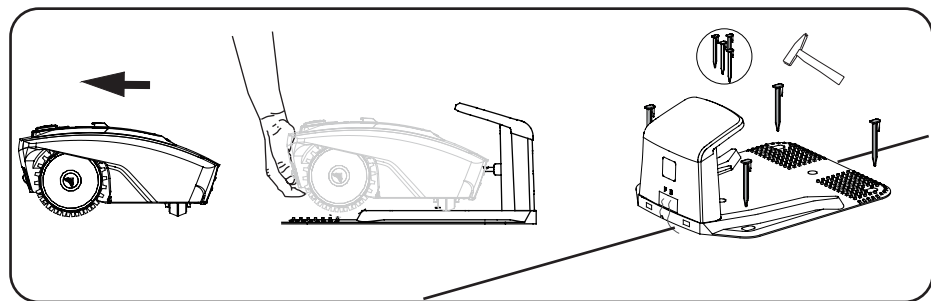

## Signal selection

**Note:** the default signal is S1, no need to change the signal when there isn't a influence signal form the neighbors.

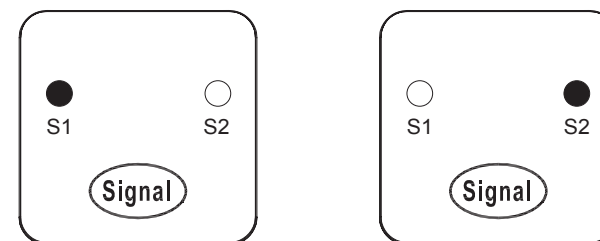

If your neighbour is using the same, will need to keep a distance of 0.5m between you and your neighbour's boundary wires to prevent the two devices interfering with each other. Ensure to position your docking station at least 10m away from your neighbour's boundary wires and that both products are using different signals. Please refer to section "Signal setting" in order to select signal S1 or S2 for your installation.

1. Press the "signal" button on the charging station, the indicator will be switched to S2.
2. Turn on your robot mower, push the mower into the charging station, after 5 seconds, the mower will be switched S2 automatically.

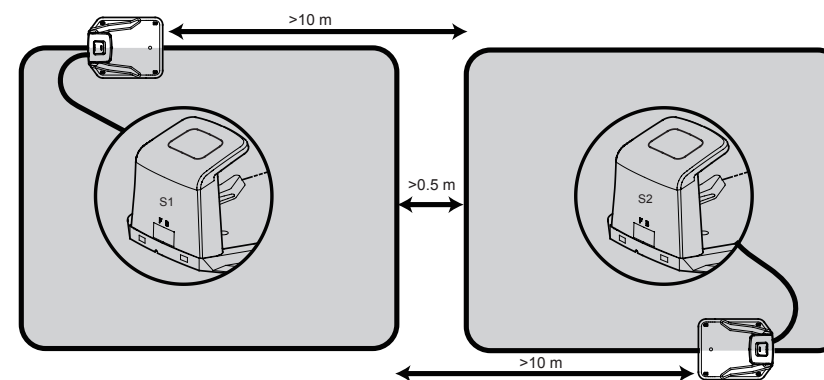

**Note:** if your mower can not be switched to the right signal after stay in the charging station, signal switch could be set manually.

1. Press and hold the button "6H" and then switch on the mower for 5s, after 5 times beep, signal is switched from S1 to S2.
2. Press and hold the button "3H" and then switch on the mower for 5s, after a long beep, signal is switched from S2 to S1.

# Operation

## Control panel

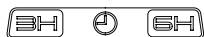
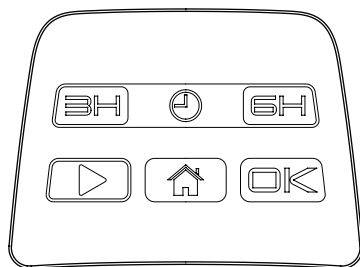

**Working time select button:**  
Select working time.



**Start button:**  
First press the Start button and then press the OK button, robotic Mower will start to work.

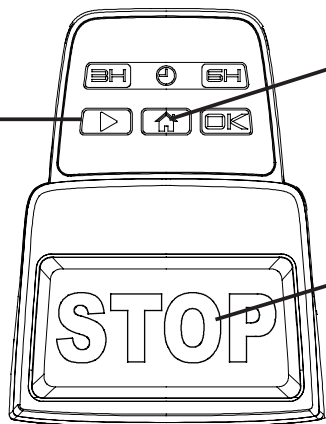

**Home button:**  
First press the Home button and then press the OK button, robotic Mower will return to docking station.

**STOP button:**  
Press this button. Robotic Mower will stop immediately.

## Start mowing

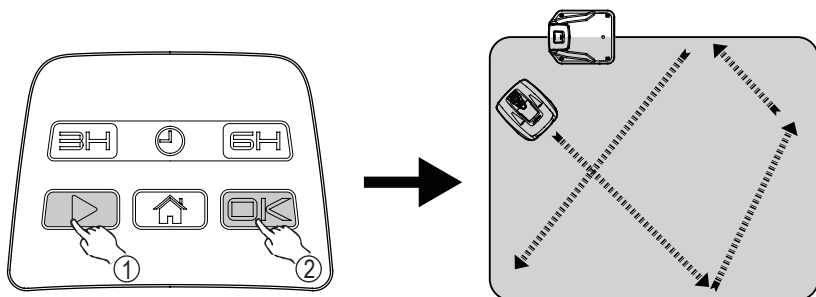

## Return to Docking station

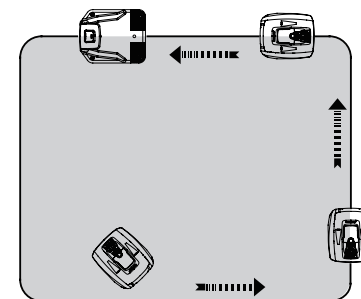
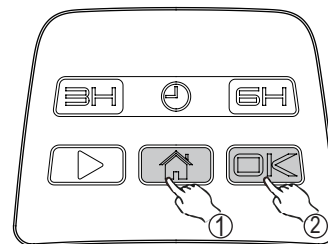

## Emergency Stop

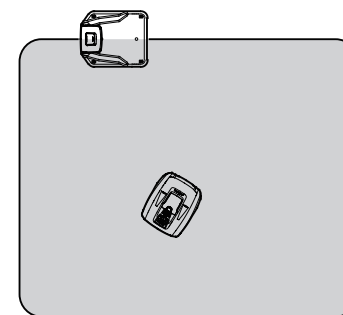

Press STOP button to halt the mower at any time.

## Cutting height adjustment

The cutting height can be adjusted by rotating the height adjustment dial located on the top of the machine. Cutting height range from 20 mm - 55 mm.

### NOTE!

We recommend using an ordinary lawn mower or trimmer to cut the lawn below 45 mm before using the Robotic Mower. This will ensure you get the optimum performance.

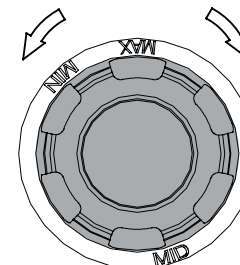
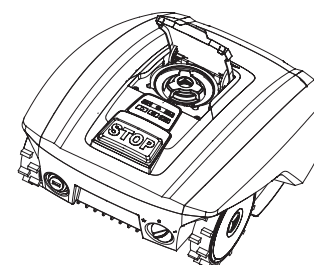

## Technical Data

Model	EasyMow 260B
Max cutting area	260 m <sup>2</sup>
Battery pack	20 V/2000 mAh
Switch power supply	Input: 100-240 V~, 50/60 Hz, 42 W Output: 24V===, CC1.5 A
Power supply model*	FY2401500S1/FY2401500S2/FY2401500S3
Mowing time on one charge	60 min
Rated voltage	20 V
Rated power	42 W
No load speed	3500 min <sup>-1</sup>
Cutting width	16 cm
Cutting height	Approx 20-55 mm
Charging time	100 min
Blade model	846210
Weight	8.2 kg
Frequency Band	0-148.5 kHz
Magnetic Field Strength	70 dBμA/m
Wireless Frequency Rang/Power	2.4-2.4835 GHz/<0 dBm
Max sound pressure level	L <sub>pA</sub> =55.8 dB, K=3 dB
Max sound power level	L <sub>WA</sub> =66.8 dB, K=3 dB
<b>Degree of protection:</b>	
Robotic Mower	IP24
Switching power supply	IP67, Plug IP44
<b>Spare parts</b>	
Spare Blades	3 Pcs
Boundary pegs	100 Pcs
Boundary wire	80 m
Connectors	3 Pcs

\* WARNING: For the purposes of recharging the battery, only use the detachable supply unit provided with this appliance.

## Maintenance and storage

Maintenance work that has not been described in these instructions must be carried out by a servicing agency authorised by the manufacturer. Only use original parts.

### Maintenance

Check and clean your Robotic Mower regularly and replace worn parts if necessary. Preferably use a dry brush, a damp cloth or a sharpened wooden piece.

Never use flushing water.

Following these maintenance instructions can extend your Robotic Mower's service life.

### Battery Life

The Robotic Mower has a maintenance free Li-ion battery, with an estimated life of more than 2 years (depending on treatment and usage).

### Winter Storage

During winter, keep your mower, docking station and power supply in a dry place.

We recommend a shed, garage or preferably store it indoors.

Prepare your device for winter storage as follows:

1. Fully recharge the battery.
2. Set the mains power switch to "OFF".
3. Thoroughly clean your Robotic Mower.
4. Unplug the power supply from the mains outlet.
5. Disconnect the power supply from the docking station.
6. Disconnect the boundary wire from the docking station. Lift up the docking station and clean. The boundary wire can remain outside. However, it is imperative to protect the wire against corrosion. We recommend a water-free grease or suitable sealing tape.

If available, repack the product in the original packaging.

Alternatively, our service centre offers a winter service for your device. This will include a check-up of all parts and - if available - a software upgrade.

### Preparing for spring

After winter storage, please clean the charging contacts on both the Robotic Mower and the docking station.

Use a fine abrasion paper or a brass brush; this will help to achieve the best charging efficiency and avoid any charging interference.

### Cleaning the mower body

As your Robotic Mower is battery powered you need take care when cleaning. Remove rough dirt with a soft brush. Use a manual water spray with mild household detergent for intensive cleaning. Wipe off any residue after cleaning with a moist rag.

### Disposal

To help the environment, please dispose of the product properly when it has reached the end of its useful life and not in the household waste. Information on collection points and their opening hours can be obtained from your local authority.

Li-ion Environmental damage through incorrect disposal of the batteries / rechargeable batteries. Remove the battery pack from the product before disposal. Batteries /rechargeable batteries may not be disposed of with the usual domestic waste. They may contain toxic heavy metals and are subject to hazardous waste treatment rules and regulations. Please dispose of batteries according to the relevant local requirements.

## Cleaning the underside

Ensure the main power switch is in OFF position. Wearing protective gloves, turn the Robotic Mower onto its side to expose its underside. Clean the blade disc and frame using a soft brush or damp cloth. Rotate the blade disc to make sure that it can move freely, check that the blades can turn on their pivots and that there is no grass is obstructing them.

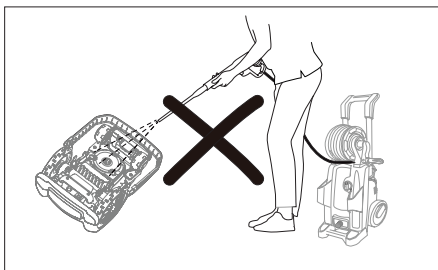

## Clean the contact pins and the charging strips

Using wire wool, metal cleaner or very fine grade emery paper, clean the contact pins and the charging strips on your mower and docking station. Remove any debris, leaves, or grass clippings around the contact pins and charging strips to ensure efficient charging.

## Reversing or replacing the blades

**WARNING!** Ensure the Robotic Mower is completely shut off before cleaning, adjusting or replacing the blades. Always wear protective gloves.

**WARNING!** To ensure maximum cutting efficiency and safety, always use recommended replacement blades and blade mounting parts when replacing.

Your Robotic Mower has three blades, fixed to the blades disk. Unless damaged by hard obstacles, these blades can last for up to five months of everyday use. Weekly inspection of the blades and the fixing screws is advised. Note that the blades are double-edged. When the first side becomes blunt, loosen the fixing screw and the blade upside down and re-fix. Check that the blade can move freely.

A set of spare blades is included with the Robotic Mower. More blades can be purchased via customer support.

To ensure you get the best performance from your machine, always replace all three blades at the same time. Only use spare parts recommended by manufacturer.

## Spare parts list

In case you need spare parts or any support with your device, please call our after sales centre.



## Software Update

Should your machine need a software update, contact our customer service team for more information.

## Troubleshooting

### Robotic Mower cannot dock with docking station

- Check that the boundary wire in front and underneath the charger is in a straight line.
- Check that the docking station's position is suitable as explained in this manual.

### Robotic Mower runs in circles while mowing or while following boundary wire back to docking station.

- Verify that no power cable runs parallel and in close proximity the boundary wire. If necessary, reposition the boundary wire.
- Check if a front wheel is stuck.
- If a neighbor has a similar Robotic Mower, the signals may interfere. Try setting your docking station and Robotic Mower are set to the alternative boundary signal.
- Driving motor may be damaged, please contact customer support/

### The Robotic Mower is noisy.

- Inspect the blade fixing screws; tighten if necessary.
- Inspect the blades for damage; replace if necessary.
- Grass may be too high. Try increasing the cutting height, or mow the lawn with an ordinary lawnmower first.
- Cutting motor failure, please call after sales service.

### Mower remains at or returns to docking station when pressing START button

- Check if the mower has already completed the programmed working time for that day.
- Battery is low, let give the Robotic Mower time to charge and try again.

### LED signal indicator on docking station

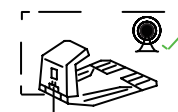
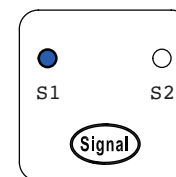

S1/S2 indicator lights on.  
Boundary wire signal in good condition

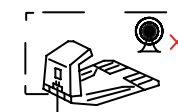
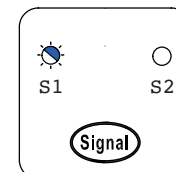

S1/S2 indicator flashes.  
Boundary wire broken, no signal.

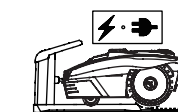
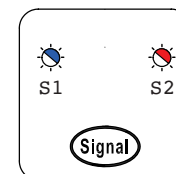

S1/S2 indicator Flashing alternately.  
Mower is charging in the docking station.

## Related to before/during/after charging

Problem	Possible cause	Corrective action
No light on charge base	Incorrect wire connection	Check wire connections " F and B"
	AC Power has not switched ON	Switch on AC power
S1/S2 indicator flashes	Boundary wire broken, no signal	Repair broken cable with provided connectors
Robot not charging	Machine not correctly docked in charge base	Check machine is fully docked in charge base
	Machine not correctly docked in charge base	Check charge base is on flat surface
	Charger pins corroded	Clean the charger pins

## Related to mowing

Problem	Possible cause	Corrective action
No Power to machine	ON/OFF key has not been activated /turned correctly	Recheck - Turn ON/OFF key knob to 1
	Robot mower has Low charge	Place machine in the charge base
Machine fails to START	Time setting not activated	Select time schedule 3-/ 6hrs - press  and OK buttons
	Grass build up under deck	Clean under deck with brush
	Battery Power Low	Place machine in charge base
	Grass too long	Mow the lawn to 45mm
	Cutting height is too Low	Mow the lawn to 45mm and raise cutting height
	Battery temperature too cold /hot	Working condition is between 5 and 45 °C
Mower outside the boundary wire	Boundary wire cut	Repair broken boundary wire
Mower outside the boundary wire	Boundary wire is on a slope	Modify boundary wire and leave bigger distance on slope
	Parts of the lawn are uncut	Increase scheduled cutting time to 6hrs
Parts of the lawn are uncut	Mower needs more cutting time	Increase scheduled cutting time to 6hrs
	Grass too long	Mow the lawn to 45mm
Mower gets stuck in Lawn area	Obstacles on lawn	Remove obstacles from the lawn
	Boundary wire not correct laid	Modify boundary wire to zone out obstacles
	Wire in front of docking station incorrect installed	2m of straight cable to front of docking station needed
Excessive vibration/noisy	Blade loose	Tighten screw bolt
	Blades damaged jammed	Replace damaged blades
	Grass maybe to high	Increase cutting height, reduce later step by step or mow the lawn with ordinary lawnmower first
	Cutting motor failure	Please call after sales service

Problem	Possible cause	Corrective action
Mower runs in circles	Power cable runs parallel/close to wire	Reposition of boundary wire
	Front wheel is stuck	Clean front wheel area
	Signal interfere with robot in neighborhood	Change to alternative boundary signal (S1/S2)
	Driving motor failure	Please call after sales service
	Connection issue or broken/cut boundary wire	Repair/check connections on charge base and boundary wire being broken/cut
Mower powered off and later powered on, and it does not mow as scheduled time	After repower or manual interruption, mower needs to input work commanding again	Press "Start + OK" or "Home + OK", this will let mower return to normal status